

## LED FLOW CELL

Type: FC3.\*.\*

### Description

The flow cell enables the use of AC1, CC1 sensor in a flow through arrangement in optoelectrochemical measurements<sup>1,2</sup>. The sensor is inserted into the slit of cell and tightened by closing of the door. The cell ensures the thin layer flow around the working electrode and it is optimised so that no air bubbles cumulate in the cell. The cell contains also the contact and output cable.

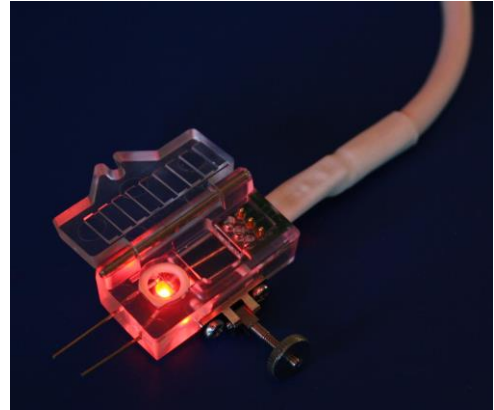

### Physical Parameters

Dimensions:

Weight: 11 gms  
Length: 42 mm  
Width: 24 mm  
Thickness: 16 mm

### LED Specification

Diameter: 3 mm  
Wave length: 350 - 2000 nm (If special laser LED is used the band width and other parameters can be specified on demand)  
Emitting angle: 27 deg

### Cell Material

- Polymethylmetacrylate

### Experimental Accessories

- Peristaltic Pump
- Linear Pump

### Flow Arrangement

### Cell Usage

- Flow measurement
- Flow-injection analysis<sup>3</sup>
- Detection of herbicides<sup>2</sup>
- Spectroelectrochemical measurements<sup>1</sup>

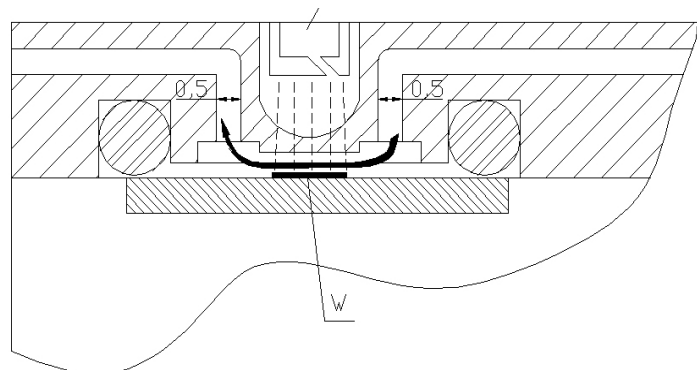

### References

1. N. Bistolos, A. Christenson, T. Ruzgas, Ch. Jung, F. W. Scheller, U. Wollenberger, Spectroelectrochemistry of cytochrome P450cam, *Biochemical and Biophysical Research Communications* 314 (2004) 810-816

## Flow cell ordering formula

FC3.\*.\* (Flow cell)

F - Flow	1 - Banana plugs
C - Cell	2 - 7 poles BVT connector
3 - Cell reference number (PMMA)	3 TRIAD - (Triad01 PalmInstruments)
* - Flow specification	3 LEMO4 - (4 pins PalmInstruments)
CG - Capillary gap cell	3 LEMO5 - (5 pins PalmInstruments)
TL - Thin layer	4 - BNC connectors
* - Termination	5 - Small banana plugs
S - Single conductors	

## Types of Termination (Three shielded core cable)

Model	Termination	Evaluating Units
FC3.*.S	Single conductors	any device
FC3.*.1	Banana plugs 4mm	any device
FC3.*.2	7 poles BVT connector	any device
FC3.*.3 TRIAD	Triad01 PalmInstruments	Palmsens, EmStat2
FC3.*.3 LEMO4	LEMO 4 pins PalmInstruments	Palmsens3, EIS, EmStat3, 3+
FC3.*.3 LEMO5	LEMO 5 pins PalmInstruments	Palmsens4
FC3.*.4	BNC connectors	any device
FC3.*.5	Small banana plugs 2mm	any device

## Example of Order

- 5 pieces - FC3.CG.S

## Ordering Information

- The order is specified by whole product code
- Minimum order quantity - 1 flow cell
- Delivery time for standard FC3 cell is 4 weeks from receipt of order
- Delivery time for non-standard FC3 cell depends on final technical specification of order

## Analyte conversion on AC1 electrochemical sensor using FC3 cell at different flow rates

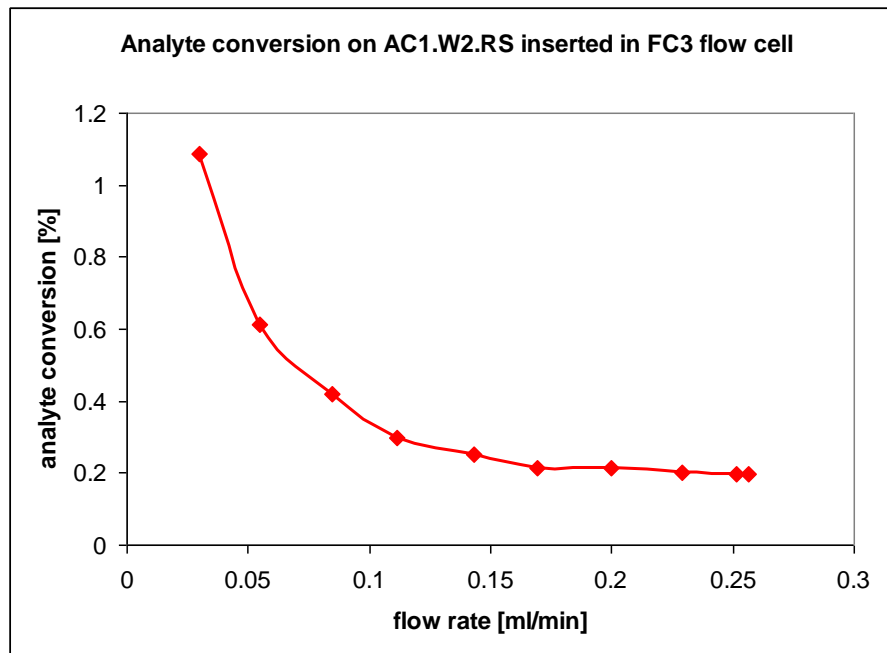

### Warnings

The parts of device which are in contact with analyzed solutions are made from PMMA - polymethylmethacrylate. Some solution components can damage the device. Following solutions were proved to damage it:

- Solutions containing chloroform
- Solutions of p-benzoquinone cause the induced creep of PMMA (aproximately after 6 month of use)
- Solutions of HCl with tetraethyl orthosilicate causes induced creep of PMMA and metal parts corrosion.

### Internal Wiring

FC3.\*.S

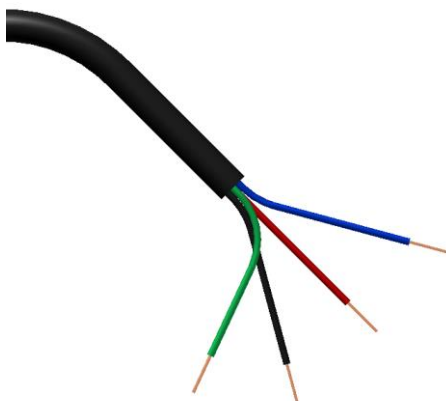

FC3.\*.1

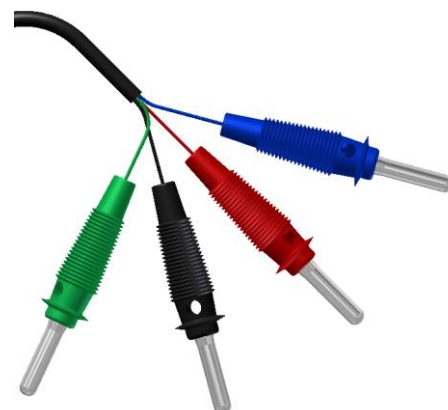

FC3. \*.2

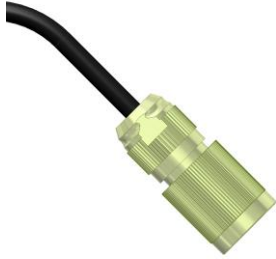

FC3. \*.3 TRIAD  
FC3. \*.3 LEMO4, FC3. \*.3 LEMO5



FC3. \*.4

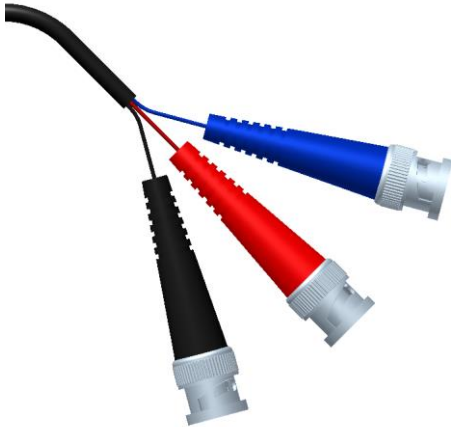

FC3. \*.5

